













CONTENTS

06

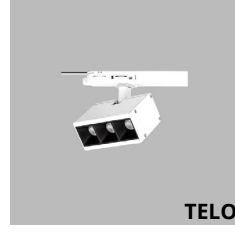
TRACKLIGHTS & MAGNETIC TRACKLIGHTS

 ELTO	 NERO	 NERO	 TAYO	 TAYO
 TEGO	 REYO	 REYO	 BENO	 BENO
 UBTO	 UBTO	 TELO	 TELO	 PARTS
 MAGNE	 MAGTE	 MAGPO	 MAGSA	 MAGYO
 PARTS	 PARTS	 PARTS		

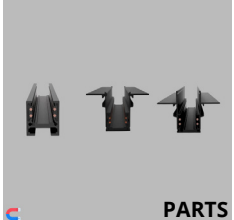

ELTO

VTR06 1220A RS30
VTR06 1220A RS40
VTR06 1220A RS60

Die Cast Body Tracklight Luminaires

Power (W)	Lumen (lm)	Efficacy (lm/W)	Kelvin (K)	Dimension (mm)axbxc	Pcs/Pack
20W	2000	100	3000 4000 6000	95x205x170	10

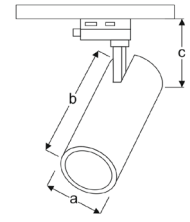

NERO

VTR06 2120B RS30
VTR06 2120B RS40
VTR06 2120B RS60

Die Cast Body Tracklight Luminaires

Power (W)	Lumen (lm)	Efficacy (lm/W)	Kelvin (K)	Dimension (mm)axbxc	Pcs/Pack
20W	2000	100	3000 4000 6000	90x110x150	10

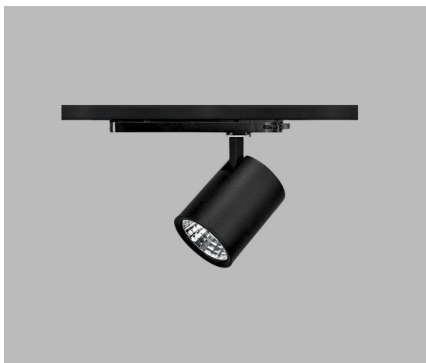
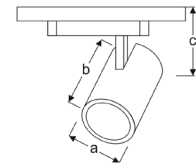

NERO

VTR06 3130B RS30
VTR06 3130B RS40
VTR06 3130B RS60

Die Cast Body Tracklight Luminaires

Power (W)	Lumen (lm)	Efficacy (lm/W)	Kelvin (K)	Dimension (mm)axbxc	Pcs/Pack
30W	3000	100	3000 4000 6000	100x120x150	10

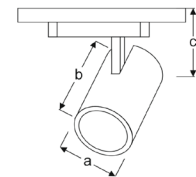

TAYO

VTR06 2120C RS30
VTR06 2120C RS40
VTR06 2120C RS60

Die Cast Body Tracklight Luminaires

Power (W)	Lumen (lm)	Efficacy (lm/W)	Kelvin (K)	Dimension (mm)axbxc	Pcs/Pack
20W	2000	100	3000 4000 6000	90x110x170	10

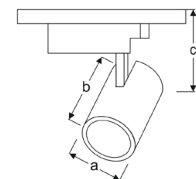

TAYO

VTR06 3130C RS30
VTR06 3130C RS40
VTR06 3130C RS60

Die Cast Body Tracklight Luminaires

Power (W)	Lumen (lm)	Efficacy (lm/W)	Kelvin (K)	Dimension (mm)axbxc	Pcs/Pack
30W	3000	100	3000 4000 6000	100x120x170	10

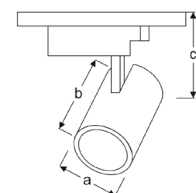



TEGO

VTR06 1120D RS30
VTR06 1120D RS40
VTR06 1120D RS60

Die Cast Body Tracklight Luminaires

Power (W)	Lumen (lm)	Efficacy (lm/W)	Kelvin (K)	Dimension (mm)axbxc	Pcs/Pack
20W	2000	100	3000 4000 6000	60x150x120	10

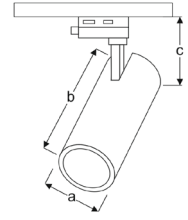

REYO

VTR06 2120E RB30
VTR06 2120E RB40
VTR06 2120E RB60

Die Cast Body Tracklight Luminaires

Power (W)	Lumen (lm)	Efficacy (lm/W)	Kelvin (K)	Dimension (mm)axbxc	Pcs/Pack
20W	2000	100	3000 4000 6000	90x120x165	10

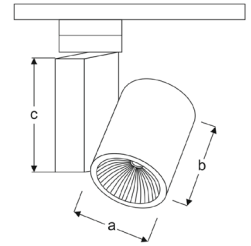

REYO

VTR06 3130E RB30
VTR06 3130E RB40
VTR06 3130E RB60

Die Cast Body Tracklight Luminaires

Power (W)	Lumen (lm)	Efficacy (lm/W)	Kelvin (K)	Dimension (mm)axbxc	Pcs/Pack
30W	3000	100	3000 4000 6000	100x120x165	10

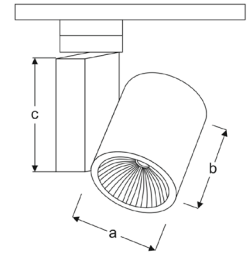

BENO

VTR06 2120F RB30
VTR06 2120F RB40
VTR06 2120F RB60

Die Cast Body Tracklight Luminaires

Power (W)	Lumen (lm)	Efficacy (lm/W)	Kelvin (K)	Dimension (mm)axbxc	Pcs/Pack
20W	2000	100	3000 4000 6000	90x120x165	10

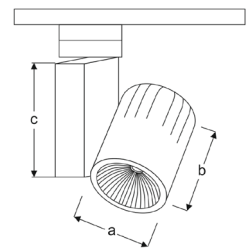

BENO

VTR06 3130F RB30
VTR06 3130F RB40
VTR06 3130F RB60

Die Cast Body Tracklight Luminaires

Power (W)	Lumen (lm)	Efficacy (lm/W)	Kelvin (K)	Dimension (mm)axbxc	Pcs/Pack
30W	3000	100	3000 4000 6000	100x120x165	10

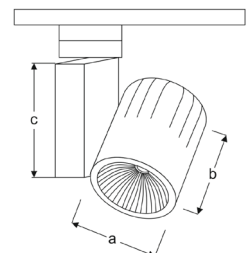



UBTO

VTR06 1110G RB30
VTR06 1110G RB40
VTR06 1110G RB60

Die Cast Body Tracklight Luminaires

Power (W)	Lumen (lm)	Efficacy (lm/W)	Kelvin (K)	Dimension (mm)axbxc	Pcs/Pack
10W	1000	100	3000 4000 6000	60x110x170	20

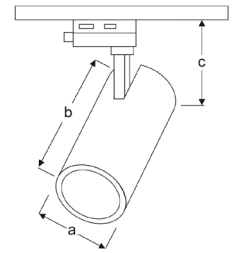

UBTO

VTR06 1210G RB30
VTR06 1210G RB40
VTR06 1210G RB60

Die Cast Body Tracklight Luminaires

Power (W)	Lumen (lm)	Efficacy (lm/W)	Kelvin (K)	Dimension (mm)axbxc	Pcs/Pack
10W	1000	100	3000 4000 6000	60x155x170	20

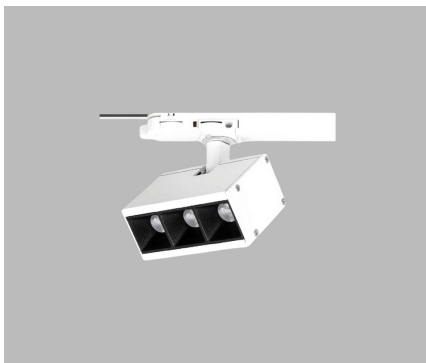
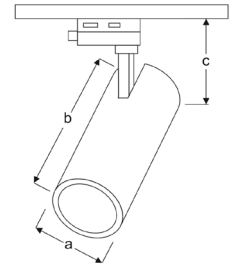

TELO

VTR06 1306H RB30
VTR06 1306H RB40
VTR06 1306H RB60

Die Cast Body Tracklight Luminaires with Lens

Power (W)	Lumen (lm)	Efficacy (lm/W)	Kelvin (K)	Dimension (mm)axbxc	Pcs/Pack
6W	720	120	3000 4000 6000	95x44x110	20

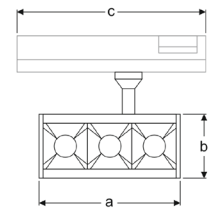

TELO

VTR06 1510H RB30
VTR06 1510H RB40
VTR06 1510H RB60

Die Cast Body Tracklight Luminaires with Lens

Power (W)	Lumen (lm)	Efficacy (lm/W)	Kelvin (K)	Dimension (mm)axbxc	Pcs/Pack
10W	1200	120	3000 4000 6000	145x44x110	10

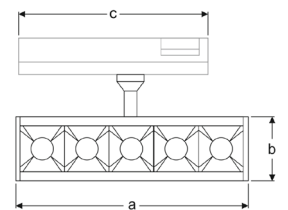

TRACKLIGHT ACCESSORIES

VTR06 1000	1 meter track	Monophase or Triphase
VTR06 2000	2 meter track	Monophase or Triphase
VTR06 3000	3 meter track	Monophase or Triphase
VTR06 I CON	I connection	Monophase or Triphase
VTR06 L CON	L connection	Monophase or Triphase
VTR06 T CON	T connection	Monophase or Triphase
VTR06 END CAP	End Cup	Monophase or Triphase

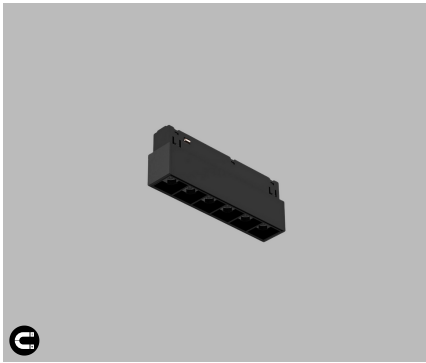

MAGNE

VTR06 1206J RS30
VTR06 1206J RS40
VTR06 1206J RS60

Magnetic Tracklight Luminaires

Power (W)	Lumen (lm)	Efficacy (lm/W)	Kelvin (K)	Dimension (mm)axbxc	Pcs/Pack
6W	100	600	3000 4000 6000	22x112x25	40

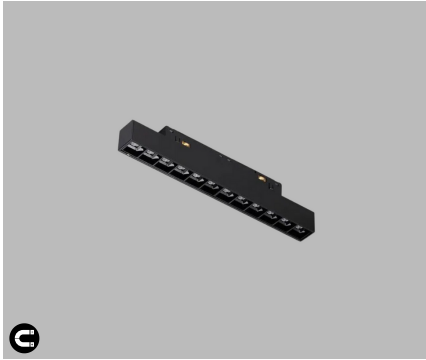
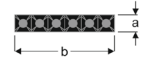

MAGNE

VTR06 2212J RS30
VTR06 2212J RS40
VTR06 2212J RS60

Magnetic Tracklight Luminaires

Power (W)	Lumen (lm)	Efficacy (lm/W)	Kelvin (K)	Dimension (mm)axbxc	Pcs/Pack
12W	1200	100	3000 4000 6000	22x222x25	30

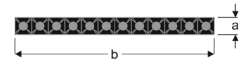
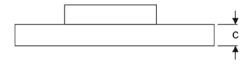

MAGNE

VTR06 3218J RS30
VTR06 3218J RS40
VTR06 3218J RS60

Magnetic Tracklight Luminaires

Power (W)	Lumen (lm)	Efficacy (lm/W)	Kelvin (K)	Dimension (mm)axbxc	Pcs/Pack
18W	1800	100	3000 4000 6000	22x328x25	20

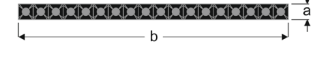
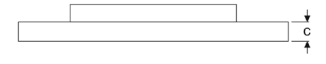

MAGTE

VTR06 1210K RS30
VTR06 1210K RS40
VTR06 1210K RS60

Magnetic Tracklight Luminaires

Power (W)	Lumen (lm)	Efficacy (lm/W)	Kelvin (K)	Dimension (mm)axbxc	Pcs/Pack
10W	1000	100	3000 4000 6000	50x132x123	30

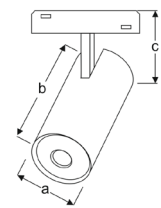

MAGTE

VTR06 2220K RS30
VTR06 2220K RS40
VTR06 2220K RS60

Magnetic Tracklight Luminaires

Power (W)	Lumen (lm)	Efficacy (lm/W)	Kelvin (K)	Dimension (mm)axbxc	Pcs/Pack
20W	2000	100	3000 4000 6000	60x150x133	20

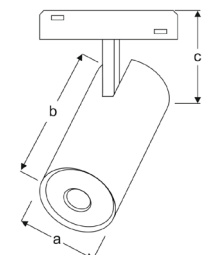

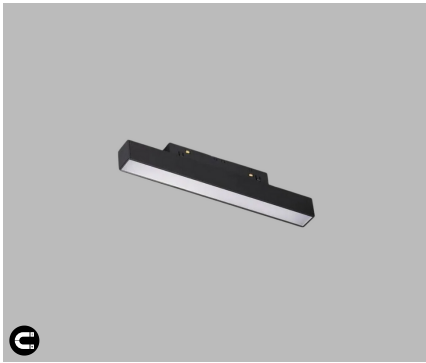

MAGPO

VTR06 1206L RS30
VTR06 1206L RS40
VTR06 1206L RS60

Magnetic Tracklight Luminaires

Power (W)	Lumen (lm)	Efficacy (lm/W)	Kelvin (K)	Dimension (mm)axbxc	Pcs/Pack
6W	600	100	3000 4000 6000	22x300x25	40

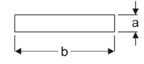

MAGPO

VTR06 2212L RS30
VTR06 2212L RS40
VTR06 2212L RS60

Magnetic Tracklight Luminaires

Power (W)	Lumen (lm)	Efficacy (lm/W)	Kelvin (K)	Dimension (mm)axbxc	Pcs/Pack
12W	1200	100	3000 4000 6000	22X600x25	30

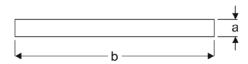

MAGPO

VTR06 3218L RS30
VTR06 3218L RS40
VTR06 3218L RS60

Magnetic Tracklight Luminaires

Power (W)	Lumen (lm)	Efficacy (lm/W)	Kelvin (K)	Dimension (mm)axbxc	Pcs/Pack
18W	1800	100	3000 4000 6000	22x900x25	20

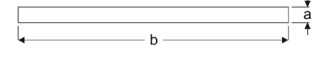
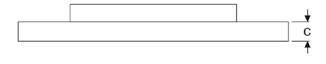

MAGSA

VTR06 1210M RS30
VTR06 1210M RS40
VTR06 1210M RS60

Magnetic Tracklight Luminaires

Power (W)	Lumen (lm)	Efficacy (lm/W)	Kelvin (K)	Dimension (mm)axbxc	Pcs/Pack
10W	1000	100	3000 4000 6000	50x155	30

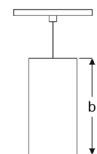

MAGSA

VTR06 2220M RS30
VTR06 2220M RS40
VTR06 2220M RS60

Magnetic Tracklight Luminaires

Power (W)	Lumen (lm)	Efficacy (lm/W)	Kelvin (K)	Dimension (mm)axbxc	Pcs/Pack
20W	2000	100	3000 4000 6000	50x300	20

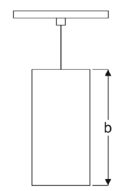

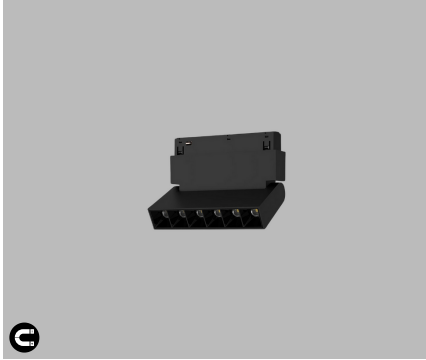

MAGYO

VTR06 1206N RS30
VTR06 1206N RS40
VTR06 1206N RS60

Magnetic Tracklight Luminaires

Power (W)	Lumen (lm)	Efficacy (lm/W)	Kelvin (K)	Dimension (mm)axbxc	Pcs/Pack
6W	600	100	3000 4000 6000	22x115x70	40

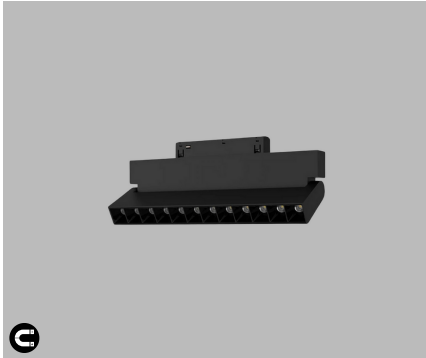
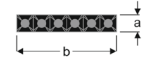
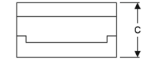

MAGYO

VTR06 2212N RS30
VTR06 2212N RS40
VTR06 2212N RS60

Magnetic Tracklight Luminaires

Power (W)	Lumen (lm)	Efficacy (lm/W)	Kelvin (K)	Dimension (mm)axbxc	Pcs/Pack
12W	1200	100	3000 4000 6000	22X223x70	30

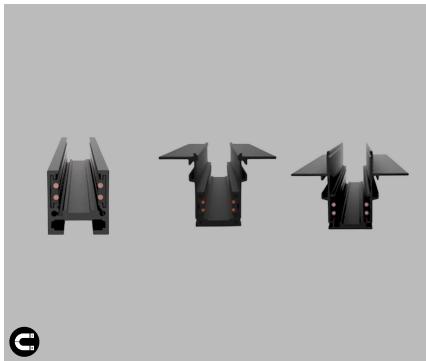
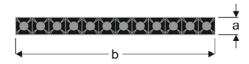

MAGNETIC TRACK ACCESSORIES

VTR06 1000S MAGNET	1 meter	Surface Magnet Track
VTR06 2000S MAGNET	2 meter	Surface Magnet Track
VTR06 1000R MAGNET	1 meter	Recessed Magnet Track
VTR06 2000R MAGNET	2 meter	Recessed Magnet Track
VTR06 1000T MAGNET	1 meter	Trimless Magnet Track
VTR06 1000T MAGNET	2 meter	Trimless Magnet Track

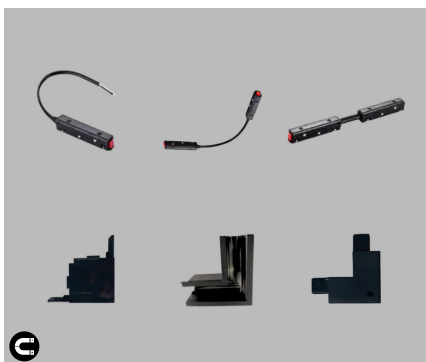

MAGNETIC TRACK ACCESSORIES

VTR06 Energy Starting	Energy Starting Part
VTR06 Flexible Connection	Flexible Connection Part
VTR06 Middle Connection	Middle Connection Part
VTR06 L Corner Connection (Wall)	L Corner Connection Profile Wall
VTR06 L Corner Connection (Recessed)	L Corner Connection Profile Recessed
VTR06 L Corner Connection (Surface)	L Corner Connection Profile Surface



MAGNETIC TRACK ACCESSORIES

VTR06 100W MAGNET DRIVER	100W Magnet Driver
VTR06 200W MAGNET DRIVER	200W Magnet Driver