

CONTENTS

02

LINEAR LIGHTING

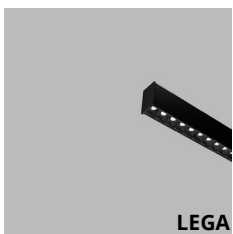

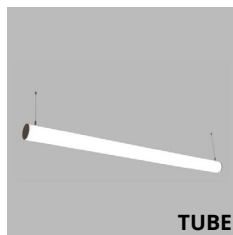
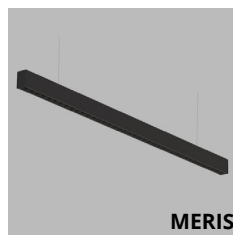
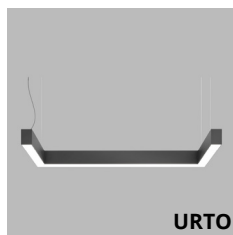
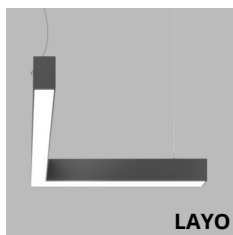
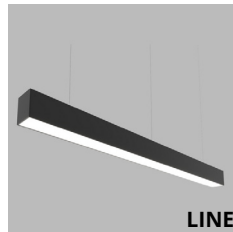
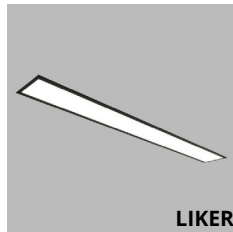
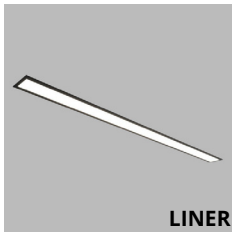
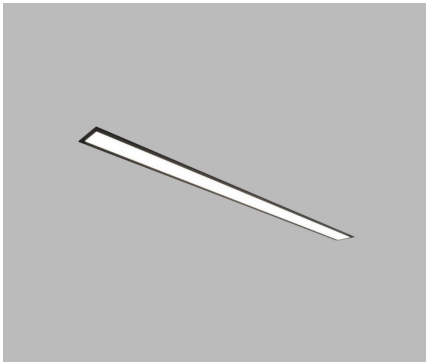

LINER

VLI02 6020A AS30
VLI02 6020A AS40
VLI02 6020A AS60

600mm Linear Thin Recessed Luminaires

Power (W)	Lumen (lm)	Efficacy (lm/W)	Kelvin (K)	Dimension (mm)axbxc	Pcs/Pack
20W	2000	100	3000 4000 6000	59x602x60	20

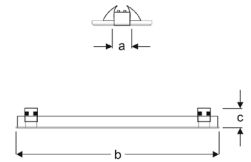

Cutout: 48x583

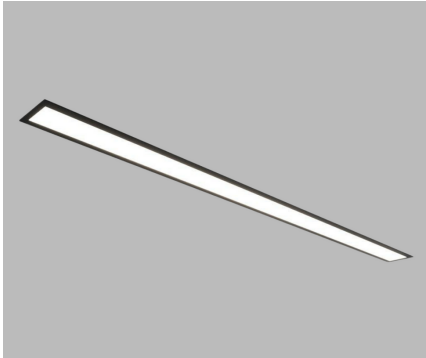

LINER

VLI02 1236A AS30
VLI02 1236A AS40
VLI02 1236A AS60

1200mm Linear Thin Recessed Luminaires

Power (W)	Lumen (lm)	Efficacy (lm/W)	Kelvin (K)	Dimension (mm)axbxc	Pcs/Pack
36W	3600	100	3000 4000 6000	59x1177x60	10

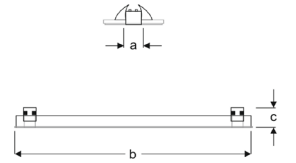

Cutout: 48x1153

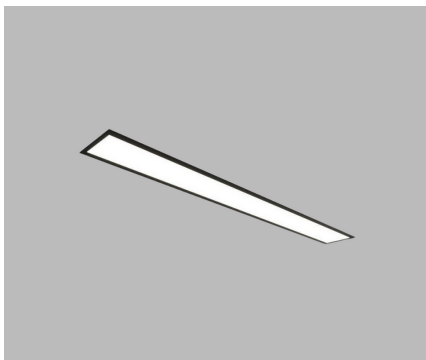

LIKER

VLI02 6020B AS30
VLI02 6020B AS40
VLI02 6020B AS60

600mm Linear Thick Recessed Luminaires

Power (W)	Lumen (lm)	Efficacy (lm/W)	Kelvin (K)	Dimension (mm)axbxc	Pcs/Pack
20W	2000	100	3000 4000 6000	86x602x75	20

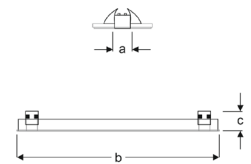

Cutout: 75x583

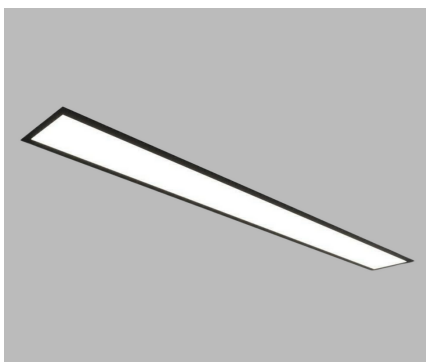

LIKER

VLI02 1236B AS30
VLI02 1236B AS40
VLI02 1236B AS60

1200mm Linear Thick Recessed Luminaires

Power (W)	Lumen (lm)	Efficacy (lm/W)	Kelvin (K)	Dimension (mm)axbxc	Pcs/Pack
36W	3600	100	3000 4000 6000	86x1172x75	10

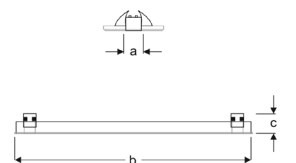

Cutout: 75x1153



LINE

VLI02 6020C SS30
VLI02 6020C SS40
VLI02 6020C SS60

600mm Linear Thin Suspended or Surface Luminaires

Power (W)	Lumen (lm)	Efficacy (lm/W)	Kelvin (K)	Dimension (mm)axbxc	Pcs/Pack
20W	2000	100	3000 4000 6000	44x585x70	20

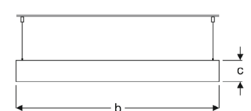
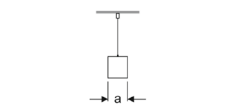

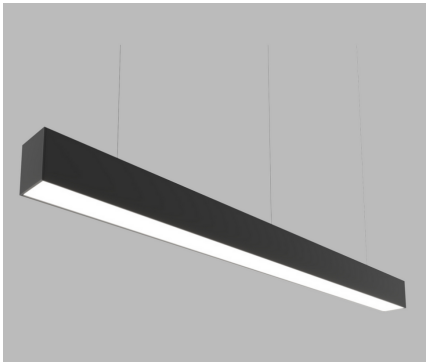

LINE

VLI02 1236C SS30
VLI02 1236C SS40
VLI02 1236C SS60

1200mm Linear Thin Suspended or Surface Luminaires

Power (W)	Lumen (lm)	Efficacy (lm/W)	Kelvin (K)	Dimension (mm)axbxc	Pcs/Pack
36W	3600	100	3000 4000 6000	44x1155x70	10

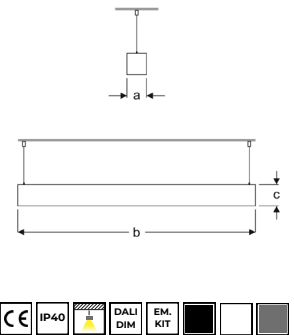

LIKA

VLI02 6020D SS30
VLI02 6020D SS40
VLI02 6020D SS60

600mm Linear Thick Suspended or Surface Luminaires

Power (W)	Lumen (lm)	Efficacy (lm/W)	Kelvin (K)	Dimension (mm)axbxc	Pcs/Pack
20W	2000	100	3000 4000 6000	70x585x86	20

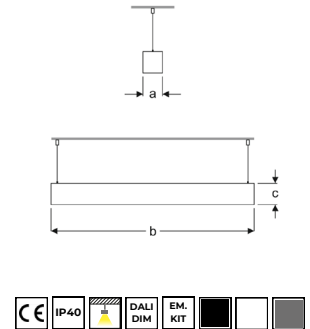

LIKA

VLI02 1236D SS30
VLI02 1236D SS40
VLI02 1236D SS60

1200mm Linear Thick Suspended or Surface Luminaires

Power (W)	Lumen (lm)	Efficacy (lm/W)	Kelvin (K)	Dimension (mm)axbxc	Pcs/Pack
36W	3600	100	3000 4000 6000	70x1155x86	10

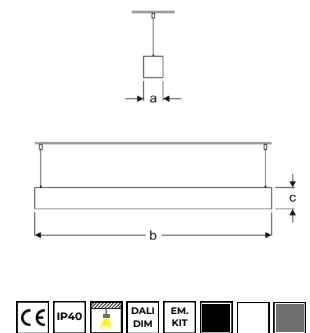

LINDE

VLI02 6020E SS30
VLI02 6020E SS40
VLI02 6020E SS60

600mm Linear Suspended or Surface Luminaires

Power (W)	Lumen (lm)	Efficacy (lm/W)	Kelvin (K)	Dimension (mm)axbxc	Pcs/Pack
20W	2000	100	3000 4000 6000	44x600x70	20

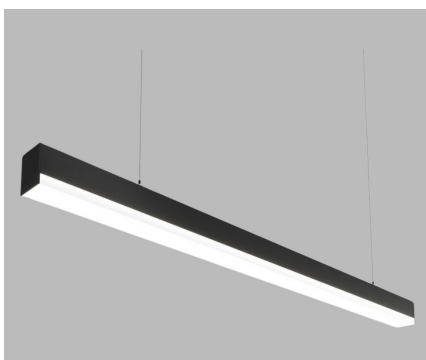
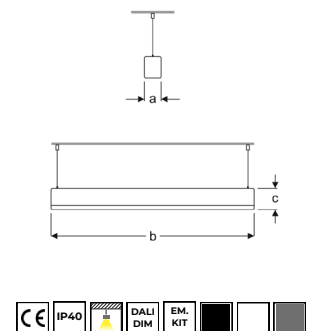

LINDE

VLI02 1236E SS30
VLI02 1236E SS40
VLI02 1236E SS60

1200mm Linear Suspended or Surface Luminaires

Power (W)	Lumen (lm)	Efficacy (lm/W)	Kelvin (K)	Dimension (mm)axbxc	Pcs/Pack
36W	3600	100	3000 4000 6000	44x1200x70	10

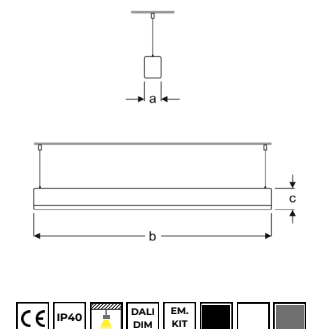

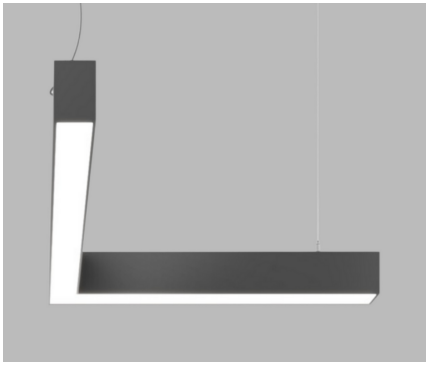

LAYO

VLI02 6636F SS30
VLI02 6636F SS40
VLI02 6636F SS60

600X600mm Linear Suspended or Surface Luminaires

Power (W)	Lumen (lm)	Efficacy (lm/W)	Kelvin (K)	Dimension (mm)axbxc	Pcs/Pack
36W	3600	100	3000 4000 6000	600x600x80	1

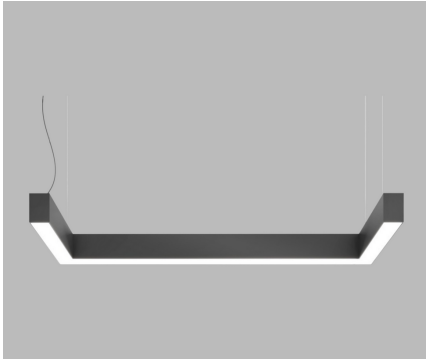
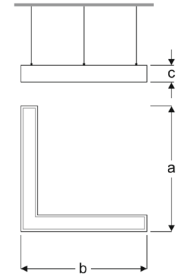

URTO

VLI02 3150G SS30
VLI02 3150G SS40
VLI02 3150G SS60

300X1000mm Linear Suspended or Surface Luminaires

Power (W)	Lumen (lm)	Efficacy (lm/W)	Kelvin (K)	Dimension (mm)axbxc	Pcs/Pack
50W	5000	100	3000 4000 6000	300x1000x80	1

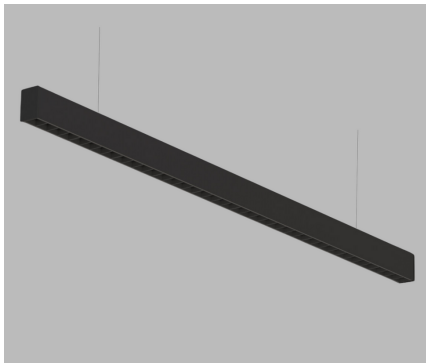
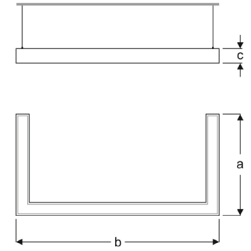

MERIS

VLI02 1240H SS30
VLI02 1240H SS40
VLI02 1240H SS60

1200mm Linear Suspended Luminaires With Lens

Power (W)	Lumen (lm)	Efficacy (lm/W)	Kelvin (K)	Dimension (mm)axbxc	Pcs/Pack
40W	5200	130	3000 4000 6000	45x1200x87	10

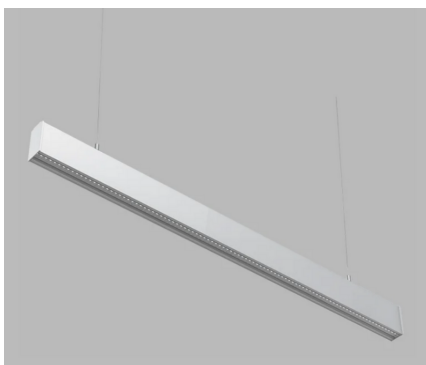
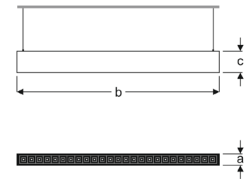

LINDO

VLI02 1240J SB30
VLI02 1240J SB40
VLI02 1240J SB60

1200mm Linear Suspended Luminaires With Lens

Power (W)	Lumen (lm)	Efficacy (lm/W)	Kelvin (K)	Dimension (mm)axbxc	Pcs/Pack
40W	5200	130	3000 4000 6000	45x1200x87	10

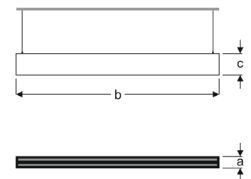

MERA

VLI02 1240K SB30
VLI02 1240K SB40
VLI02 1240K SB60

300x1200mm Linear Suspended or Surface Luminaires

Power (W)	Lumen (lm)	Efficacy (lm/W)	Kelvin (K)	Dimension (mm)axbxc	Pcs/Pack
40W	5200	130	3000 4000 6000	300x1200x60	4

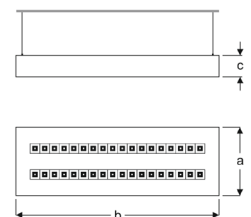

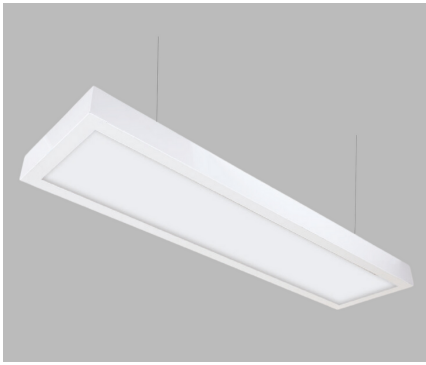

ETRA

VLI02 3136L SB30
VLI02 3136L SB40
VLI02 3136L SB60

300x1200mm Linear Suspended Luminaires

Power (W)	Lumen (lm)	Efficacy (lm/W)	Kelvin (K)	Dimension (mm)axbxc	Pcs/Pack
36W	3600	100	3000 4000 6000	300x1200x60	4

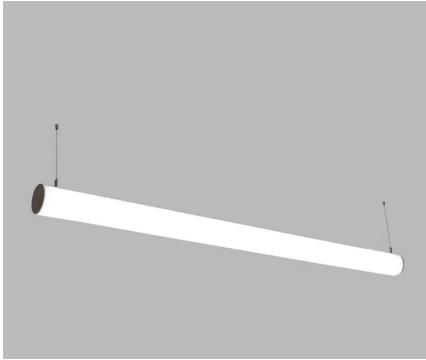
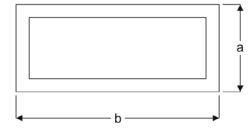
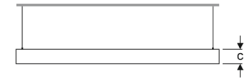

TUBE

VLI02 1236M SB30
VLI02 1236M SB40
VLI02 1236M SB60

1200mm Linear Suspended or Surface Luminaires

Power (W)	Lumen (lm)	Efficacy (lm/W)	Kelvin (K)	Dimension (mm)axbxc	Pcs/Pack
36W	3600	100	3000 4000 6000	80x1200x80	4

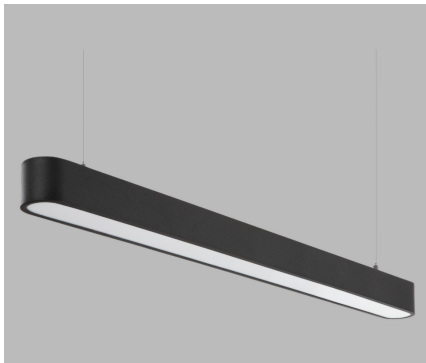
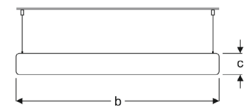

RALIN

VLI02 1236N SS30
VLI02 1236N SS40
VLI02 1236N SS60

1200mm Linear Suspended or Surface Luminaires

Power (W)	Lumen (lm)	Efficacy (lm/W)	Kelvin (K)	Dimension (mm)axbxc	Pcs/Pack
36W	3600	100	3000 4000 6000	80x1200x75	4

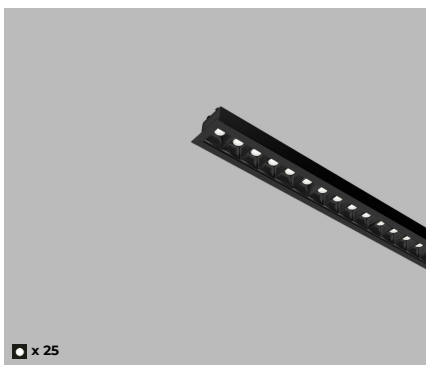
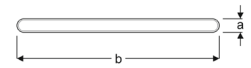

x 25

MESA

VLI02 6025P AS30
VLI02 6025P AS40
VLI02 6025P AS60

660mm Linear Recessed Luminaires With Lens

Power (W)	Lumen (lm)	Efficacy (lm/W)	Kelvin (K)	Dimension (mm)axbxc	Pcs/Pack
25W	3000	120	3000 4000 6000	50x660x65	20

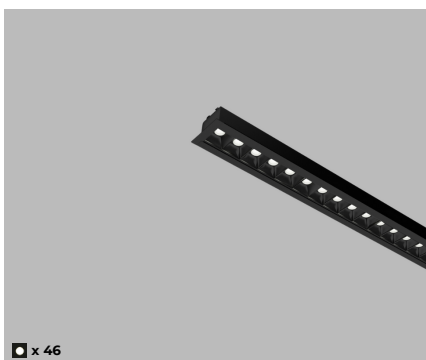
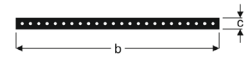

x 46

MESA

VLI02 1245P AS30
VLI02 1245P AS40
VLI02 1245P AS60

1200mm Linear Recessed Luminaires With Lens

Power (W)	Lumen (lm)	Efficacy (lm/W)	Kelvin (K)	Dimension (mm)axbxc	Pcs/Pack
45W	5400	120	3000 4000 6000	50x1200x65	10

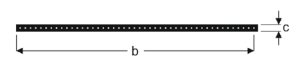



MEREN

VLI02 6023J AS30
VLI02 6023J AS40
VLI02 6023J AS60

660mm Linear Suspended or Surface Luminaires

Power (W)	Lumen (lm)	Efficacy (lm/W)	Kelvin (K)	Dimension (mm)axbxc	Pcs/Pack
23W	2760	120	3000 4000 6000	50x660x65	20

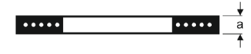
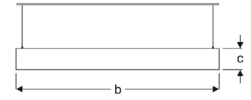

MEREN

VLI02 1240J AS30
VLI02 1240J AS40
VLI02 1240J AS60

1200mm Linear Suspended or Surface Luminaires

Power (W)	Lumen (lm)	Efficacy (lm/W)	Kelvin (K)	Dimension (mm)axbxc	Pcs/Pack
40W	4800	120	3000 4000 6000	50x1200x65	10

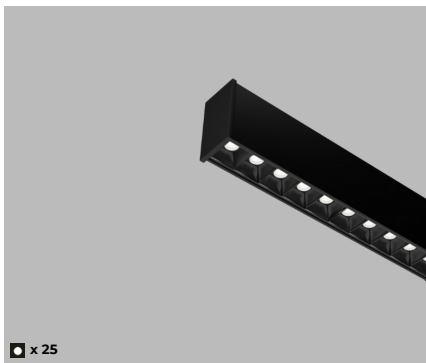
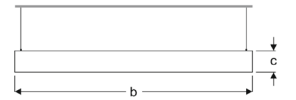

LEGA

VLI02 6025K SS30
VLI02 6025K SS40
VLI02 6025K SS60

660mm Linear Suspended or Surface Luminaires

Power (W)	Lumen (lm)	Efficacy (lm/W)	Kelvin (K)	Dimension (mm)axbxc	Pcs/Pack
25W	3000	120	3000 4000 6000	35x660x66	20

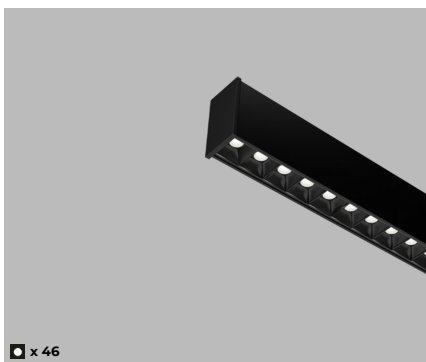
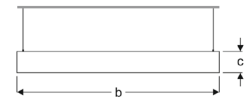

LEGA

VLI02 1245K SS30
VLI02 1245K SS40
VLI02 1245K SS60

1200mm Linear Suspended or Surface Luminaires

Power (W)	Lumen (lm)	Efficacy (lm/W)	Kelvin (K)	Dimension (mm)axbxc	Pcs/Pack
45W	5400	120	3000 4000 6000	35x1200x66	10

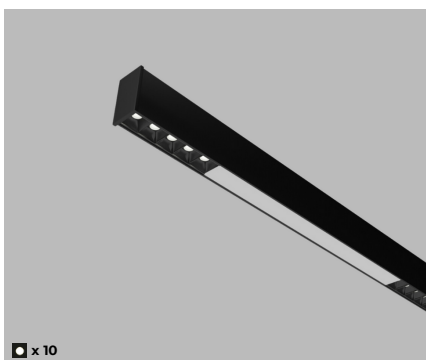
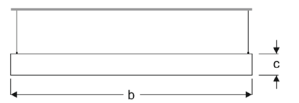

LERAN

VLI02 6023L SS30
VLI02 6023L SS40
VLI02 6023L SS60

660mm Linear Suspended or Surface Luminaires

Power (W)	Lumen (lm)	Efficacy (lm/W)	Kelvin (K)	Dimension (mm)axbxc	Pcs/Pack
23W	2760	120	3000 4000 6000	35x660x66	20

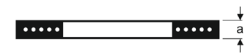
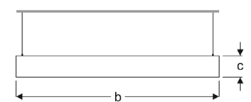

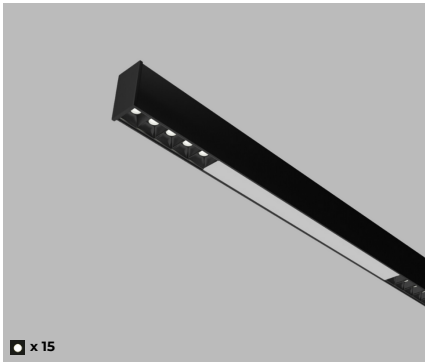

LERAN

VLI02 1240L SS30
VLI02 1240L SS40
VLI02 1240L SS60

1200mm Linear Suspended or Surface Luminaires

Power (W)	Lumen (lm)	Efficacy (lm/W)	Kelvin (K)	Dimension (mm)axbxc	Pcs/Pack
40W	4800	120	3000 4000 6000	35x1200x66	10

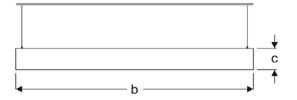

TULA

VLI02 6023M SS30
VLI02 6023M SS40
VLI02 6023M SS60

660mm Linear Suspended Luminaires

Power (W)	Lumen (lm)	Efficacy (lm/W)	Kelvin (K)	Dimension (mm)axbxc	Pcs/Pack
23W	2760	120	3000 4000 6000	62x660x57	20

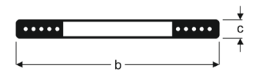

TULA

VLI02 1245M SS30
VLI02 1245M SS40
VLI02 1245M SS60

1200mm Linear Suspended Luminaires

Power (W)	Lumen (lm)	Efficacy (lm/W)	Kelvin (K)	Dimension (mm)axbxc	Pcs/Pack
45W	5400	120	3000 4000 6000	62x1200x57	10

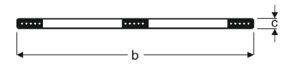

LORI

VLI02 6023N SS30
VLI02 6023N SS40
VLI02 6023N SS60

660mm Linear Suspended or Surface Luminaires

Power (W)	Lumen (lm)	Efficacy (lm/W)	Kelvin (K)	Dimension (mm)axbxc	Pcs/Pack
23W	2760	120	3000 4000 6000	35x660x66	20

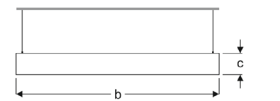

LORI

VLI02 1245N SS30
VLI02 1245N SS40
VLI02 1245N SS60

1200mm Linear Suspended or Surface Luminaires

Power (W)	Lumen (lm)	Efficacy (lm/W)	Kelvin (K)	Dimension (mm)axbxc	Pcs/Pack
45W	5400	120	3000 4000 6000	35x1200x66	10

